

GLASS DECK MOUNT

9023 TOP RAIL

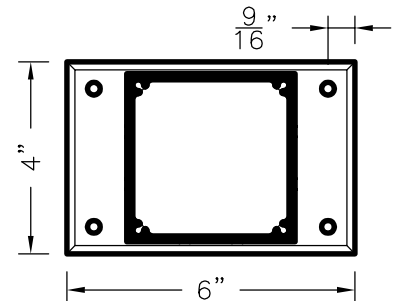
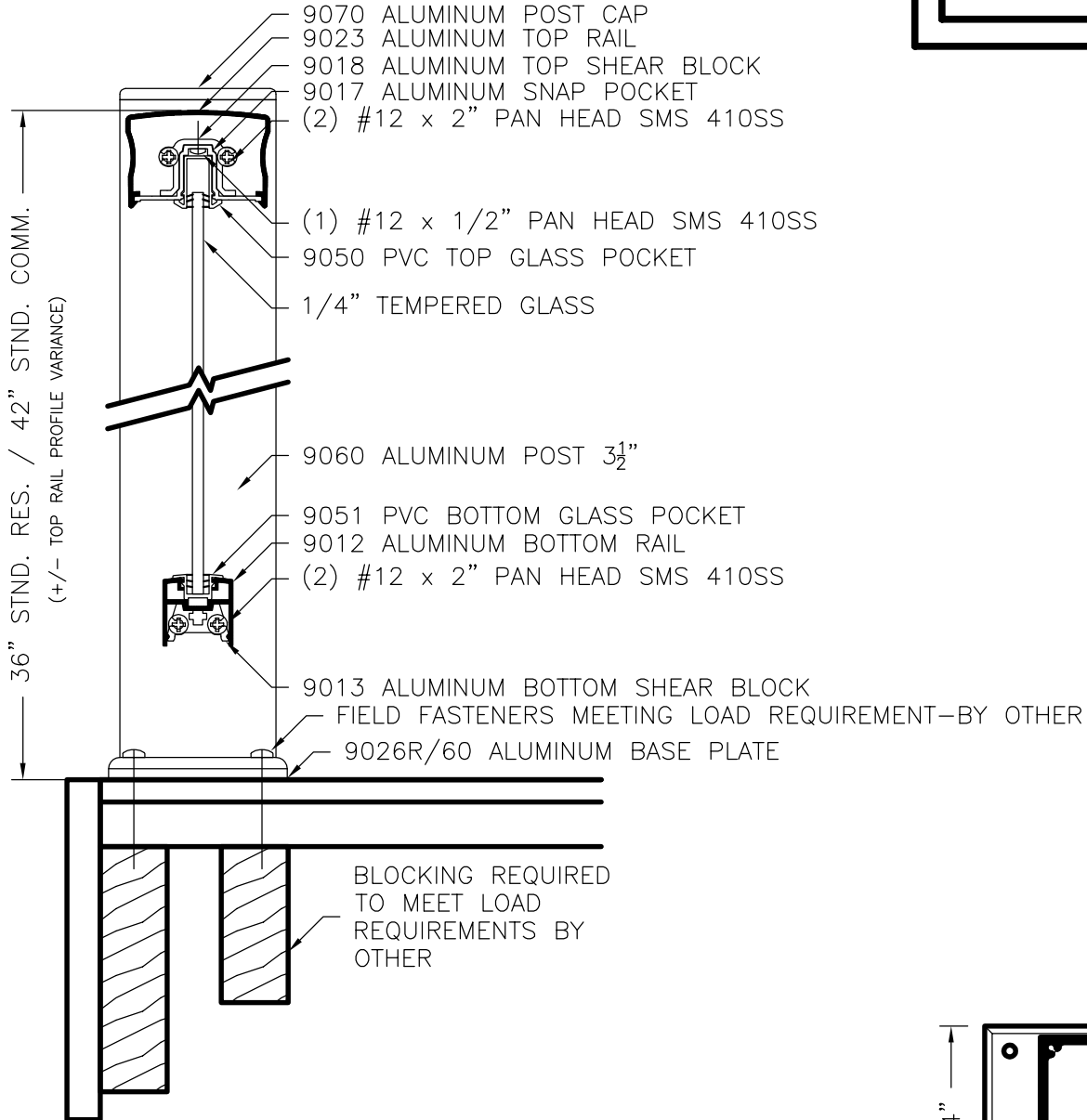
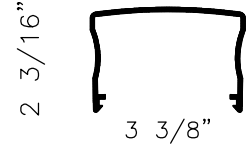

9026R BASE PLATE

1/4 SCALE

GENERIC DETAILS.
 ACTUAL DESIGN AND MAKE-UP VARY AS REQUIRED.

BASE PLATE PARALLEL STND.
 PERPENDICULAR MAY BE REQUIRED

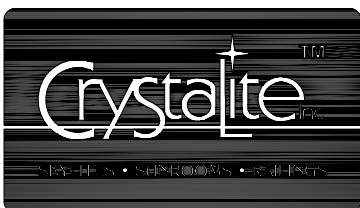

9023 TOP RAIL & 9060 POST

Crystalite railings are structurally designed and stamped by an independent structural engineer. Crystalite railing systems have been rated to accommodate high wind loads and exposure ratings set forth by local building codes. Crystalite will select the appropriate post size and spacing to meet code requirements, exposure criteria, with wind speeds up to 120 mph.